

**artist360●**

**Exhibitor dossier**

(What you need to know before you apply)

Madrid, September 14 – 17, 2023 (**Apertura Madrid Weekend Gallery**)

Contemporary  
Art Fair

## Contents

- What is Artist360
- Apertura Madrid Weekend Gallery Edition
- Artist360 figures
- Art for all
- Fair specification
- What Artist360 offers you
- The exhibition área
- Cómo participar en Artist360
- Terms and conditions
- Floor plan
- Management team

## What is Artist360

We introduce a new concept of art fair that rescues the figure of the artist and its leading role on the contemporary art scene.

Pitching for a direct dialogue with the public under a self-representation model or through Art Galleries that share the same need with us: to look back at the figure of the artist.

This is a unique opportunity to approach and experience art works through the eyes its very creator.

Under the motto **Art for All**, from Artist360 we support a new culture of art collecting, oriented to both the established collector as well as to those who access this exciting world for the first time.

Promoting and helping society to perceive art more closely, fleeing from the speculative distortions to which art has been subjected in recent times.

## The APERTURA Edition, Madrid Weekend Gallery

This edition is held from September **14 to the 17, 2023**, simultaneously to the **Madrid Weekend Gallery Opening APERTURA**; a week during which Madrid becomes the focus of the art world, a great cultural event when numerous Madrid art galleries and museums open their exhibitions with long running hours.

Promoted by Arte Madrid (Association of Modern and Contemporary Art Galleries of Madrid), the week aims, after the summer, to bring the public closer to contemporary artistic creation.

This event attracts collectors, experts and curators from all over the world, as well as the art-loving public that usually attends this type of events.

Artist360 in figures \*

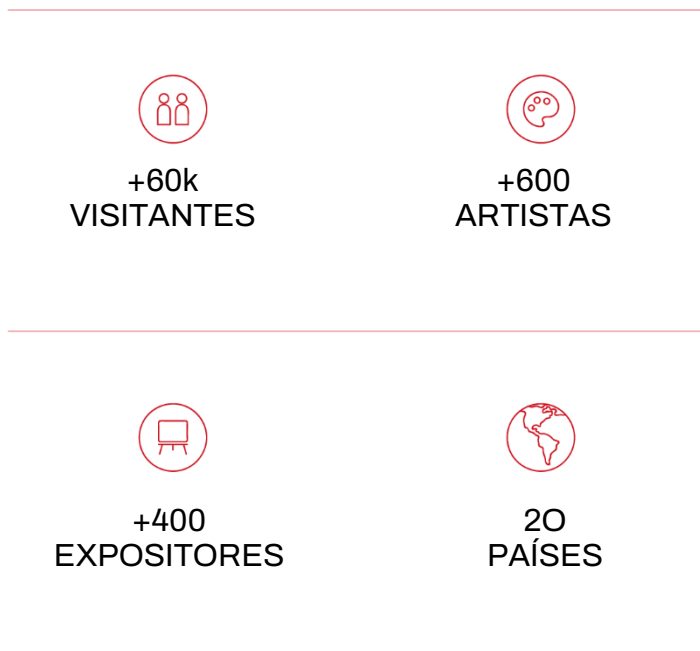

With great success in the past editions: 2020, 2021, 2022 and 2023, both in terms of artist participation, public attendance and sales, **our fair consolidates its artistic proposal in this 5th edition** by presenting an exhibition project that aspires to innovate and evolve the concept of the conventional art fair.

**Art for All** is entering a different dimension where the interaction with the art enthusiastic public takes place through multiple relational channels: from the essential presence of artworks (exhibitions and fairs), to the different digital formats that the new technologies provide us with and that allow for your art work to be always accessible to the public.

\*  
Cifras acumuladas a partir de los datos de ediciones anteriores

## Art for all

From Artist360 we offer 3 key formats that prompt the wide spreading of high quality artistic proposals, thus guaranteeing a continuous and permanent exhibition experience.

Where professionals and public can find the right way to connect at any time and place.

- 1. Contemporary Art Fair**
- 2. Marketplace**
- 3. Temporary exhibitions**

### ○ 1. Contemporary Art Fair

Artist360 organizes face-to-face art fairs at key moments of the artistic calendar such as the **Madrid Contemporary Art Week** and **Madrid Weekend Gallery APERTURA**.

-  
The dynamics of this exhibition format provide an excellent opportunity for artists, both established and upcoming, as well as art galleries that want to make their art works visible for 5 consecutive days (this is the duration of all of our fairs) before a selected but large audience such as the regular visitor to Artist360 (20 thousand visits in our last edition, February 2023).

Although it is a conventional exhibition format Artist 360° have evolved that model towards a different art fair concept where the visitor experiences closeness and freshness.

The free access for the visitor, the wide artistic offer at very reasonable prices, a parallel program of activities and live performances, make the event a unique opportunity to enjoy art from a different perspective that steams from our essence: Art Withing Your Reach.

## 2. Marketplace

"In one click and in a few days you can hang a piece of art work in your house", That simple, that easy. With this new initiative we want to bring art to any home at attractive prices, quickly and easily. You just have to select the preferred work of art from our new online platform; the rest is on us.

-

We do not finish our mission at the art fair, in addition to participating in our face-to-face editions, Artist 360° offers you its **new on-line exhibition channel** to permanently show and share your new creations, to facilitate sales and to send them directly from your studio to the collector's house. We are in charge of everything: from exhibition, to marketing, from sales to logistics.

In this way, the potential collector that you contact in your stand at our fair will be able to follow your art work and purchase it at any given time through our online platform. We provide you with a technological solution that you can even integrate into your own website immediately and seamlessly.

Designed with all our emotion to bring your art work to any home at any time.

## 3. Temporary exhibitions

We also come to your city, your streets,... nearby places where you can enjoy curated exhibitions in spaces that until now were excluded from the conventional art circuits.

-

In Artist 360° we challenge conventions: at the lobby of that hotel that has always dazzled you, at the corporate headquarters of a large corporation, at the airport terminal while you wait for your flight... **places where art comes in naturally in daily life.**

The "emotion" of appreciating a showcased art work, acquiring it instantly and being able to receive it at home in a few days.

**Find emotions any time, any place.**

## Fair specification

Edition: Madrid Weekend Gallery APERTURA

- Name: Artist360 Contemporary Art Fair
- Dates: **September 14 – 17, 2023**
- Location: Ilunion Pío XII Convention Center
- Address: Av. Pío XII, 77 Madrid
- Area: 1000 m2
- Opening days
 

Thursday	14/09/23 11:00-21:00 h
Friday	15/09/23 11:00-21:00 h
Saturday	16/09/23 11:00-21:00 h
Sunday	17/09/23 11:00-20:00 h

- Free admission

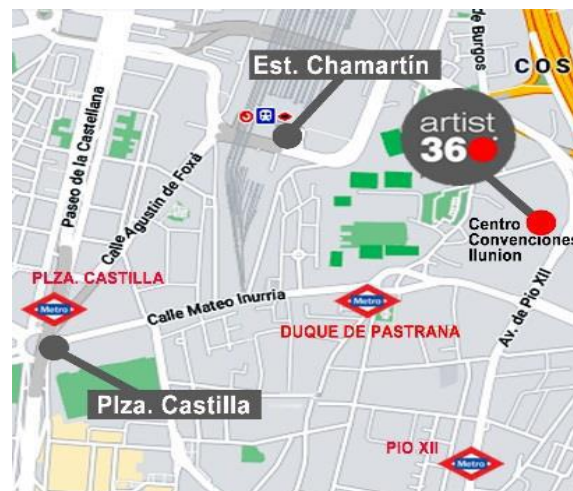

- Access
 

Walking: 15 min from Plza. de Castilla  
6 min from Metro Pio XII  
7 min from Metro Duque de Pastrana

Metro: Pío XII | Duque de Pastrana
- Promociona: Artist 360 Art Fairs S.L.
- Contact: [info@artist360madrid.com](mailto:info@artist360madrid.com)  
+34 616 616 909

## What Artist360 offers you

For art galleries, established artists, mid-career and emerging artists: Artist360 offers you an excellent opportunity to exhibit and present your artistic proposal in an unbeatable setting in Madrid, choosing the time of the year that best suits your professional schedule and adapting the necessary space according to your needs and professional guidelines.

-

Artist360 fair offers you:

- Exhibit for 4 or 5 days at key moments in the art scene
- In a privileged location in Madrid
- Have a unique and differentiated space as an exhibitor
- Advertising campaign in mass media and social media
- Sales of works without inter-mediation or commissions
- Includes all services: Wi-Fi, furniture, insurance, advertising...
- With all promotional support included
- No initial registration costs



Additionally, from our 2021 edition, we present a new tool that complements the face-to-face fair: the 360° Virtual Platform.

-

It is a virtual space where each gallery and artist will have an exhibition room in which each artistic proposal can be assessed in advance from any digital device. A virtual tour that will show the space and layout of each art work in 3D mode, in a quasi-real environment.

The visitor will be able to organize its visit anticipating their preferences, identifying artists or works of interest, contacting and arranging meetings with exhibitors. The 360° Virtual Platform is an additional service that can be optionally contracted.



## The exhibition area

### 1000 m2 distributed in spacious rooms.

For art galleries, established, mid-career or emerging artists: Artist 360° offers you an excellent opportunity to exhibit and present your artistic proposal in an unbeatable setting in Madrid, choosing the time of the year that best suits your professional schedule and adapting the necessary space according to your needs and professional guidelines.

-

The Ilunion Pio XII Convention Center is located in a strategic area of modern Madrid, at the heart of the Chamartín district, next to the central Plaza de Castilla and the Chamartín – Clara Campoamor Station, on one of the main avenues in the north of Madrid.

Artist 360° takes place in this large exhibition space and adjacent terrace (under a tent) and will host up of 90 stands. The venue has a secured parking for better convenience and offers free stays depending on the days of the week.

The space is next to a hotel that offers discounted rates for exhibitors plus an excellent gastronomic offer.



## Cómo participar en Artist360



### How to participate in Artist360

Artists, galleries and art collectives that work in painting, sculpture, drawing, printmaking, photography, digital art and other visual art disciplines.



### How to send your proposal

You must register your proposal through our registration form on our website . The registration process is free and will be available until the Fair's capacity is reached



### Selection process

A curatorial committee, along with the fair management team, will assess each proposal and determine its suitability to participate.

Response in 1 week



### Exhibition areas of the fair

Artist360 Fair offers different stand options with formats and dimensions to meet your criteria, your artistic expectations and goals, as well as your investment budget.

With a total of 90 stands aligned that extend into the open and common areas of the Ilunion Pío XII Convention Center, occupying the interior and exterior space attached (under a tent). A cubic space with glass walls bathed in natural light, with wide corridors and elegant garden decoration.



### Spaces availability, dimensions and prices

During your proposal registration, we will ask you to select the type of space in which you wish to participate/exhibit.

Once the proposal has been evaluated and accepted by our curatorial committee, you have to definitively formalize your participation by confirming the space required.

All the spaces have the same equipment and exhibition facilities, their prices vary according to location and dimensions in exhibition running meters\*, as shown below.

\* The spaces are sized according to the linear meters that form the perimeter of their walls.

**Stand A**  
**2.800 €**  
 (galerías y grandes formatos)  
 - 12 m lineales exposición  
 - 2,65m de altura  
 - focos LED 50W  
 - 1 mesa + 2 sillas  
 - Cartel + vinilo

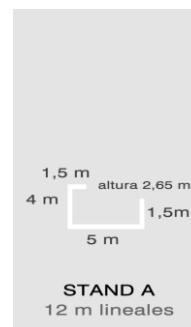

**Stand B**  
**1.650 €**  
 - 6 m lineales exposición  
 - 2,65m de altura  
 - focos LED 50W  
 - 1 mesa + 2 sillas  
 - Cartel + vinilo

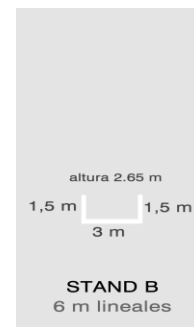

**Stand C**  
**1.100 €**  
 - 3,5 m lineales exposición  
 - 2,65m de altura  
 - focos LED 50W  
 - 1 mesa + 2 sillas  
 - Cartel + vinilo

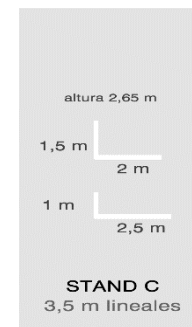



---

**Stand A**  
**2.800 €**  
Grandes formatos  
y galerías de arte  
  
Ancho:  
1,5 + 4 + 5 + 1,5 m  
**12 m lineales**  
Altura: 2,65 m

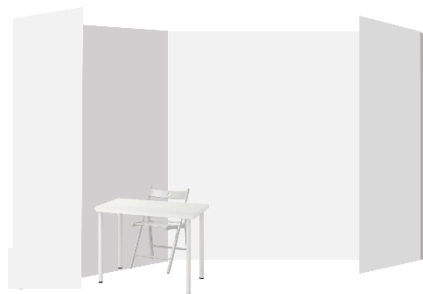

---

**Stand B**  
**1.650 €**  
  
Ancho:  
1,5 + 3 + 1,5 m  
**6 m lineales**  
Altura: 2,65 m

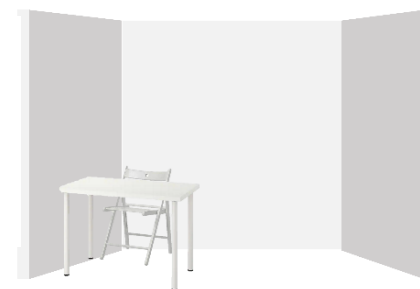

---

**Stand C**  
**1.100 €**  
  
Ancho:  
2 + 1,5 m  
1 + 2,5 m  
**3,5 m lineales**  
Altura: 2,65 m



**Parallel activities and entertainment at Artist360**

ARTIST360 Fair offers a parallel program of activities that take place in the adjacent areas to the exhibition hall which offer an attractive complement for both the exhibitor and the visiting public.

The program includes: talks and presentations, artistic performances, live music, in addition to the leisure and gastronomic complement that the venue offers: cafeterias, restaurants and terraces.

An attractive plus that makes the fair an ideal event where you can, in addition to enjoying the art works, culminate the visit with a moment of leisure and entertainment

**Accommodation at advantageous rates**

Artist 360° Fair has reached an agreement with the following hotels near the exhibition venue, allowing our exhibitors to enjoy accommodation at a preferential rate:

- Hotel Ilunion Pío XII Annex to the exhibition hall of the Fair.
- Hotel Nuevo Madrid, at a 15-minute walk from the exhibition hall of the fair.

In both cases a great convenience for exhibitors, avoiding daily transfers and providing superb logistical support for your exhibition



## Terms and conditions



### Once your proposal is accepted

Once your proposal is accepted by our Curatorial Committee, you will have to sign your participation contract.

The entire process will be carried out electronically through our website



### What does your participation include?

In addition to the stand, Spot lighting and Wi-Fi, the price of the stand includes:

- Furniture (chair and table)
- Promotional campaign on the web and social media
- Label and identification vinyl
- Mass Media advertising campaign
- Liability insurance
- Promotional and advertising material
- Exhibition advice and support



### Payment terms

The registration and management of your proposal is free and you will only have to assume the payment of the stand once your proposal has been accepted and the "participation contract" has been formalized.

- 50% of the total at the signing of the contract (maximum 10 days after the signing of the contract)
- 50% of the total before August 10, 2023



**Dates to keep in mind**

Apertura Madrid Weekend Gallery Madrid, from September 14 to the 17, 2023

- March 20, 2023: Campaign launch and opening registration
- July 15, 2023: Graphic materials
- August 19, 2023: Payment 100%
- September 13, 2023 Assembly
- September 14 to 17, 2023: fair
- September 17, 2023: Disassembly from 20:00 to 00:00h

Floor Plan



Feria de Arte Contemporáneo  
Apertura Weekend Gallery - Madrid | 14-17 septiembre 2023

ILUNION Centro de Convenciones Ilunion Pío XII

FLOOR PLAN

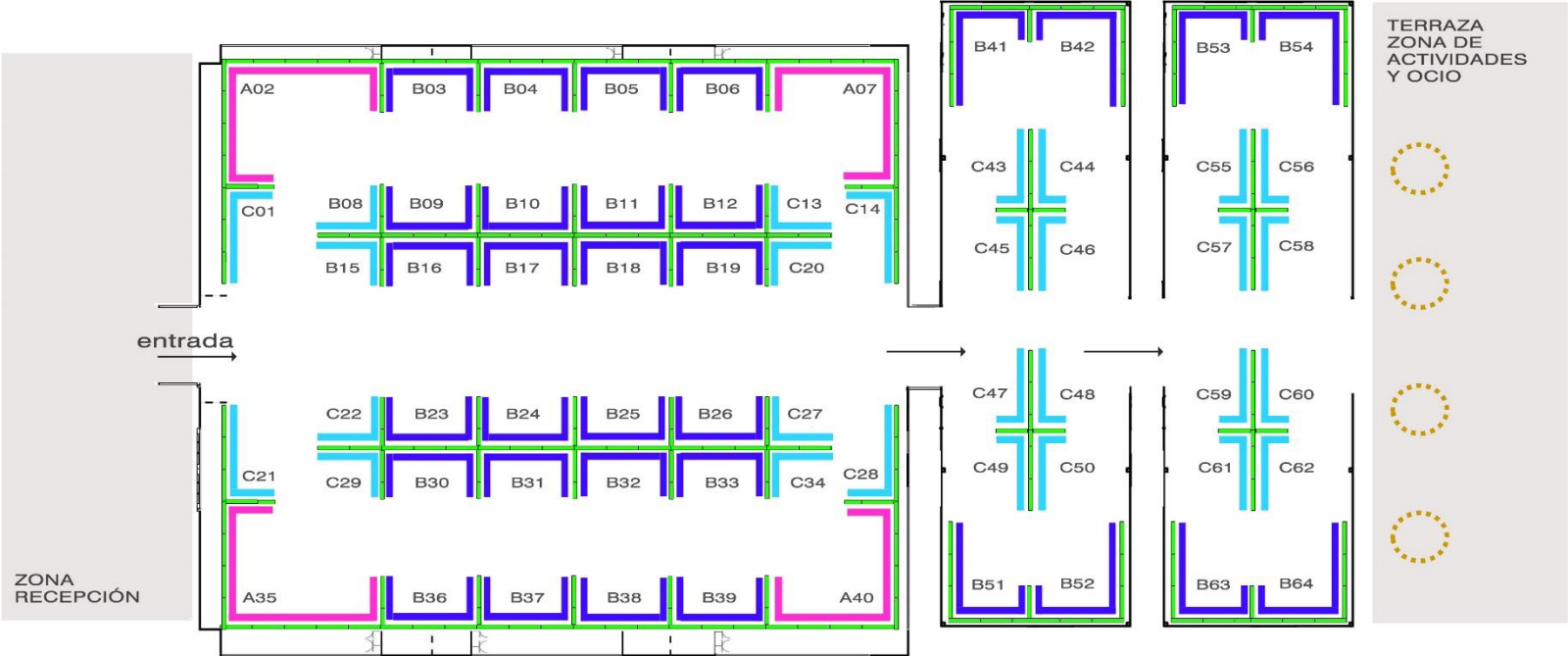

TIPOS DE STANDS

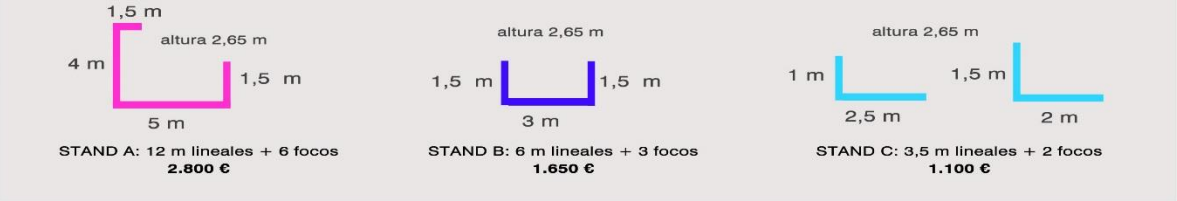



## Management Team

Artist360's management is integrated by artists with first-hand knowledge and proven experience of the entire artistic production cycle, from its creative phase to its staging in large exhibition projects (institutional exhibitions, national and international fairs, etc. ).

Aware of the shortcomings of the market and the barriers it presents for all its players, the Artist 360° team embarks on an innovative experience that democratizes art, removing the invisible barriers that have placed Art in an "unreachable" place for society, and even for the artist her/himself

- **Management**

Moisés Bentata  
[mbentata@artist360madrid.com](mailto:mbentata@artist360madrid.com)  
+34 616 616 909

- **Curator**

Santi Delgado  
[santidelgado@hotmail.com](mailto:santidelgado@hotmail.com)

- **Comunicación e imagen**

Silvia Chaparro  
[comunicacion@artist360madrid.com](mailto:comunicacion@artist360madrid.com)

Those interested in being part of Artist360 Contemporary Art fair, can complete the registration form available on our website, at the information section for exhibitors.

Our Curatorial Committee will evaluate the proposal and we will contact you within 1 week.

If you have any questions or queries, you can contact us by phone or by sending an email to:

**[info@artist360madrid.com](mailto:info@artist360madrid.com)**